

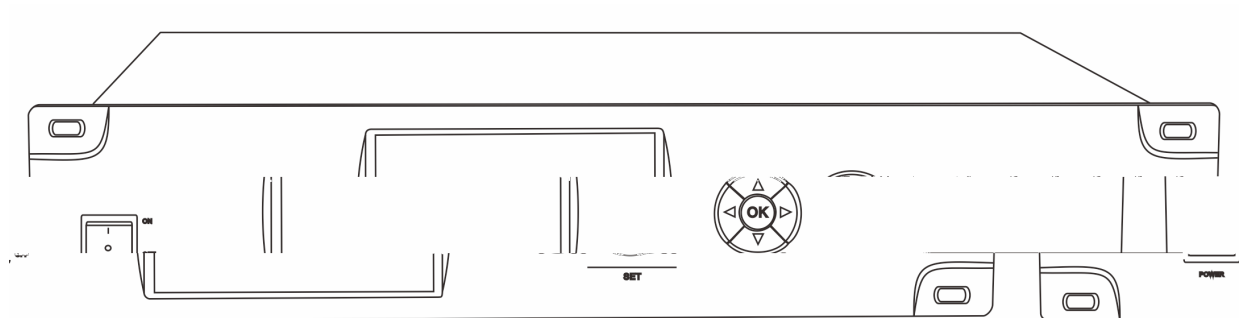

DIGIRATE





3

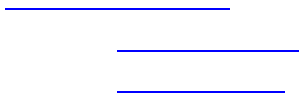



DO NOT TO REDUCE THE RISK OF ELECTRIC SHOCK, EXPOSE THIS EQUIPMENT TO RAIN OR MOISTURE.

shock, CAUTION: To reduce the risk of electric shock, DO NOT open covers, no user serviceable parts. personnel.

目者设备 这个闪电标识，是提醒使用 中出现的未绝缘的危险电压 可能导致人遭受电击。

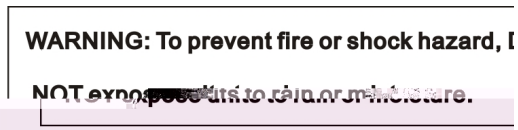
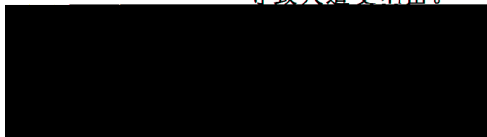

注意：请勿让设备暴露在雨或潮湿环境中。 电工服务人员进行设备维护

拔除电源：无论设备是否

可以进 打到的位置时，设

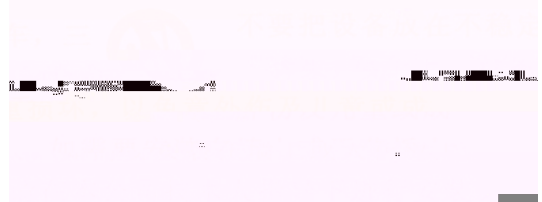

■

■

▲

▲

■

▲

▲

■

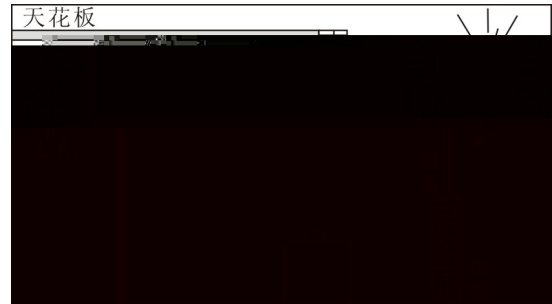

6.1

■

▲

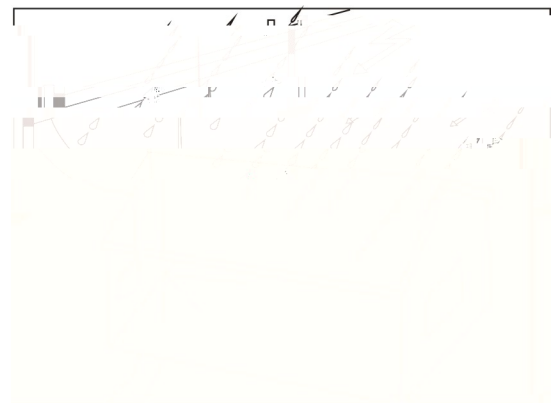

6.2

■

▲

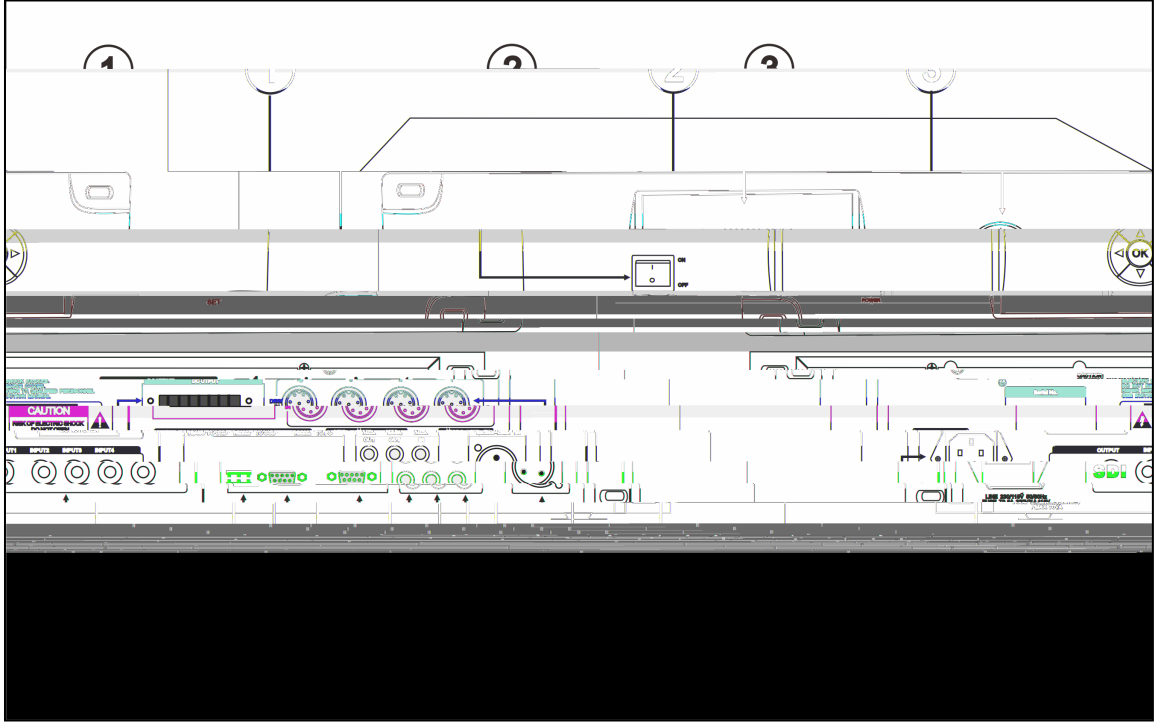

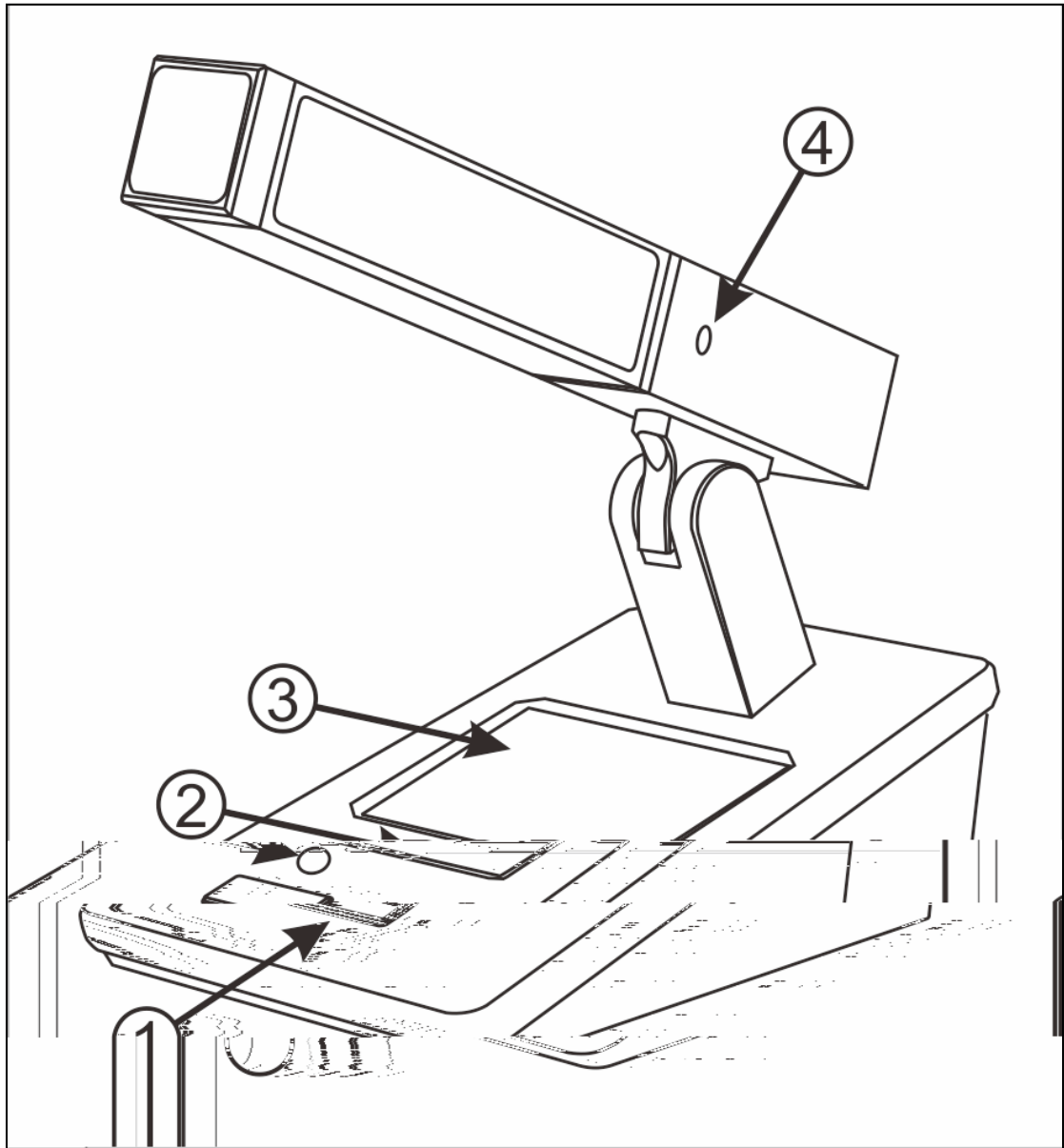

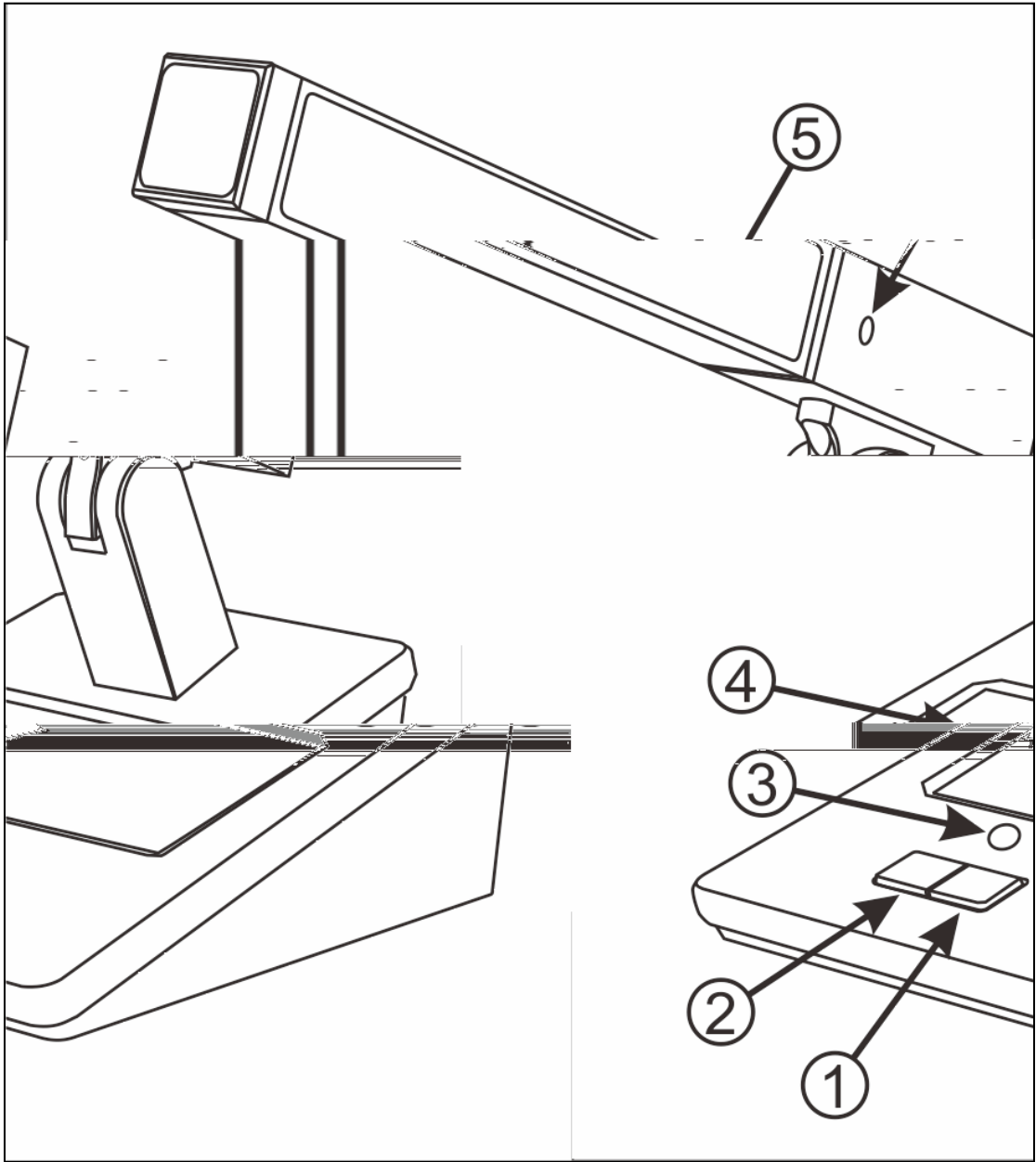

■

■



▲

■

■

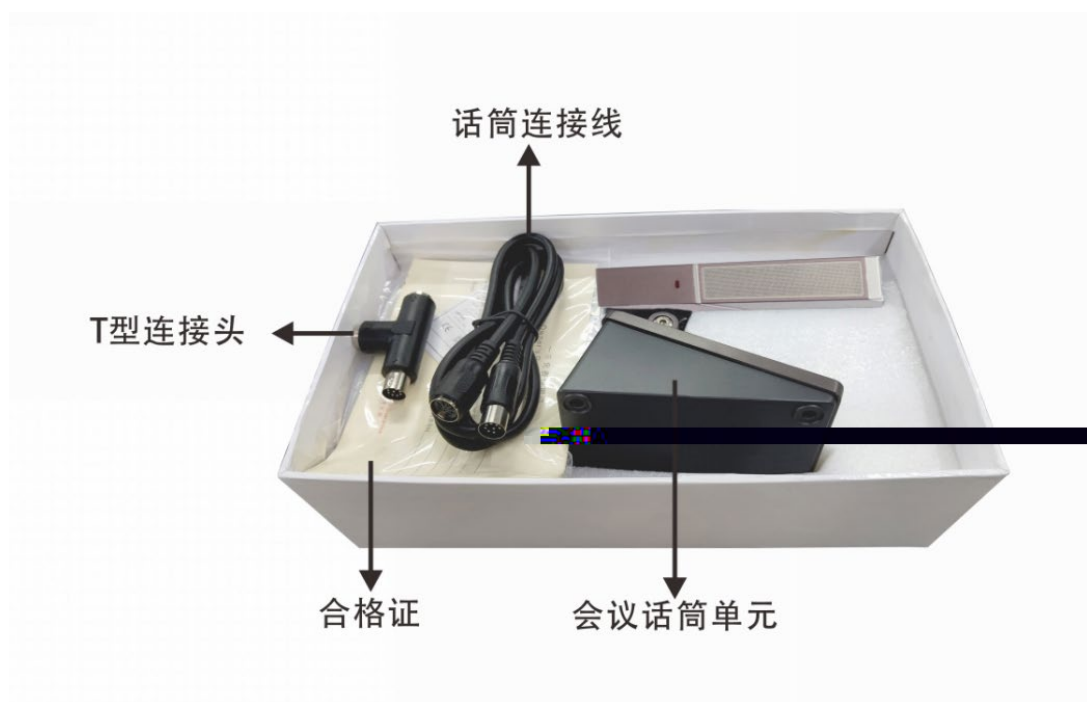

■

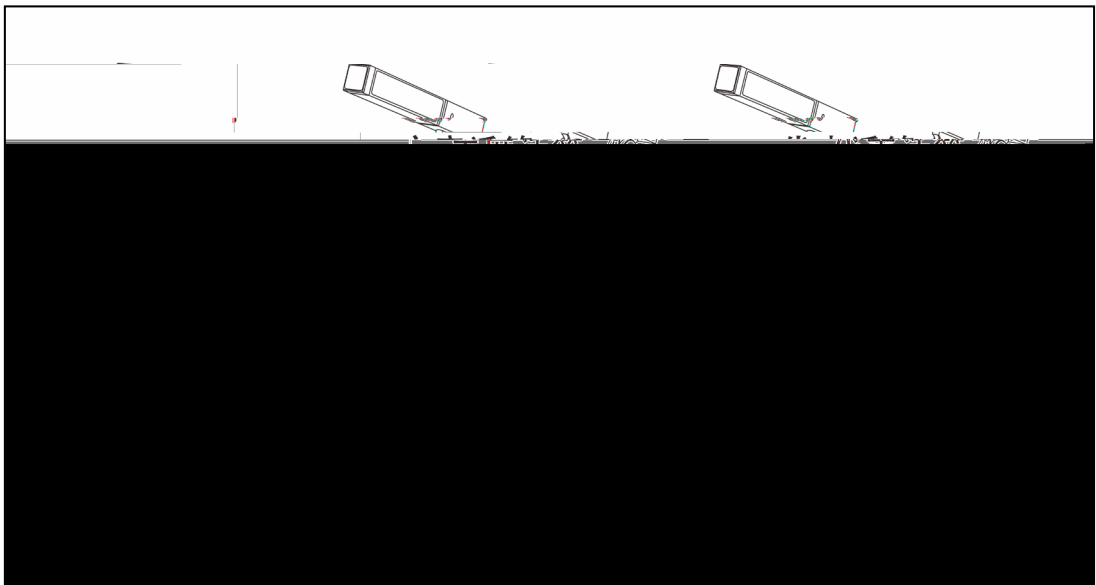
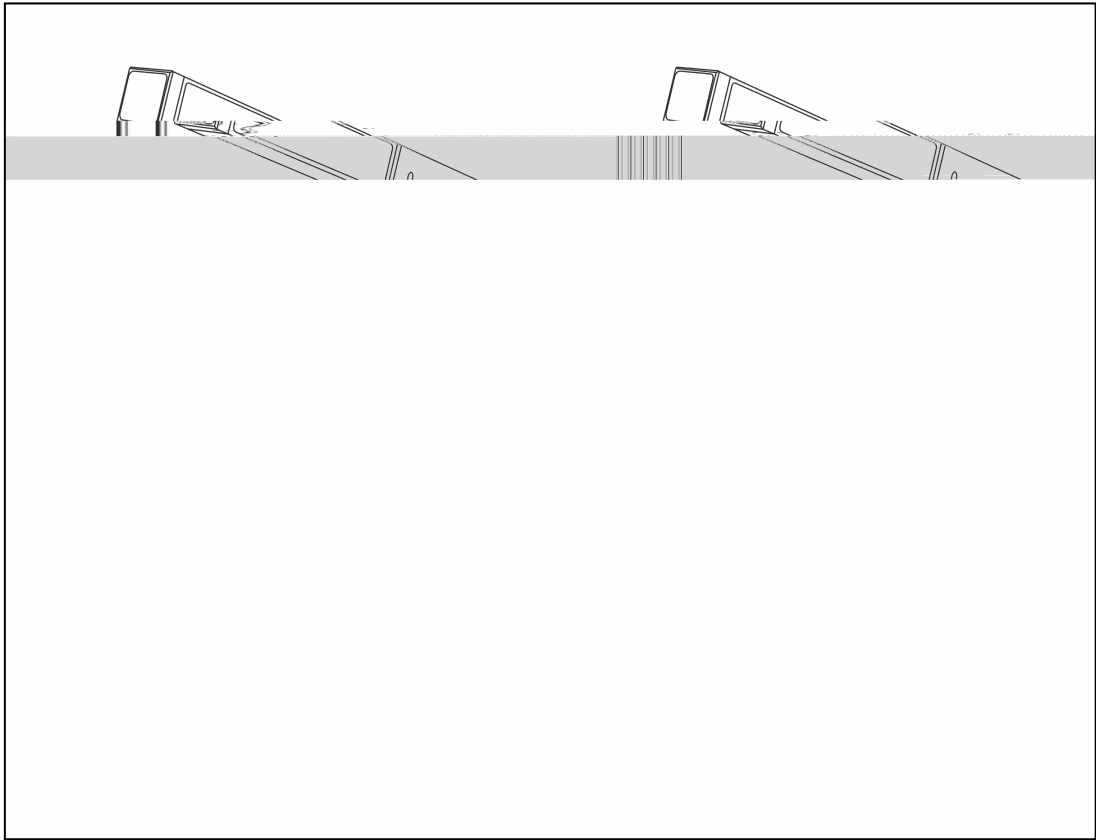

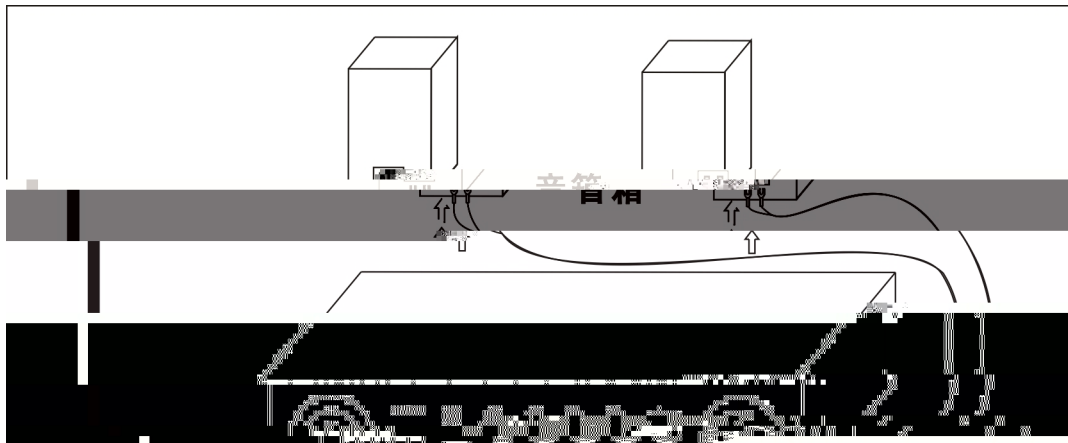
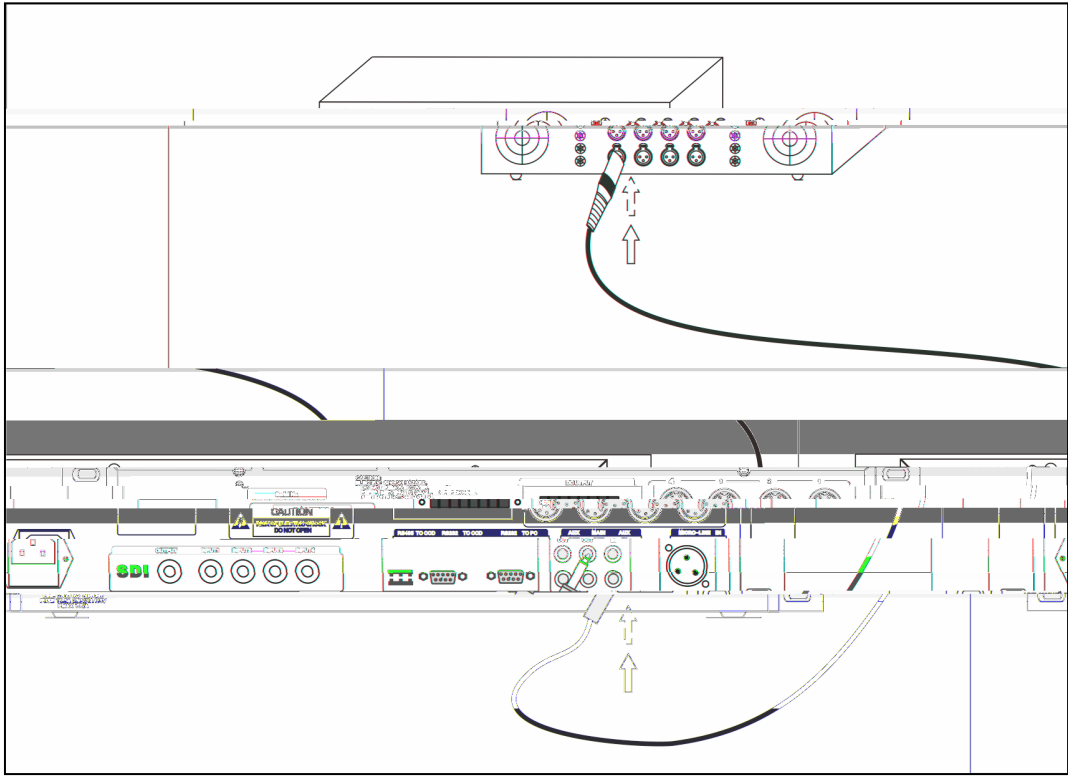

□

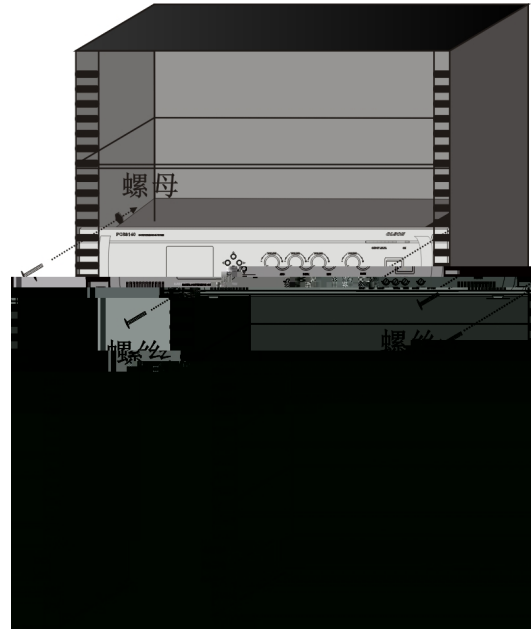

15.1

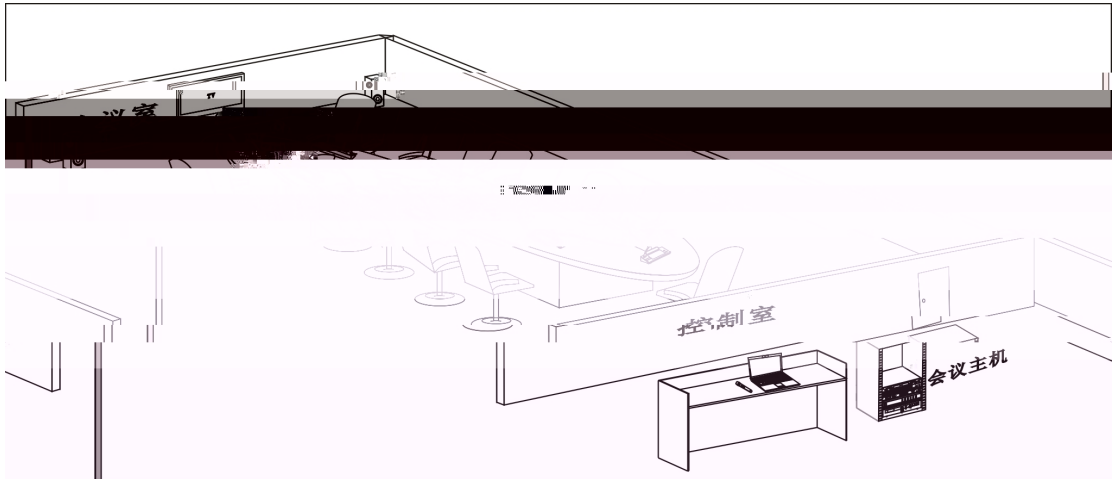



	20-20KHZ +3 dB
	>80 dB
	0.1% AT1KHz
	-80 dB
	482*321*88 mm



	3.5
	20-20000 Hz
	-36 dB
	200
	136 dB
	9.7 X1
	16 dB
	DC 24V
	0.8Kg
	(x x) 182 * 32 * 25.6 mm
	(x x) 107.5 x 145.9 x 50.8 mm
	1



合 議 事 錄



21.1

2.

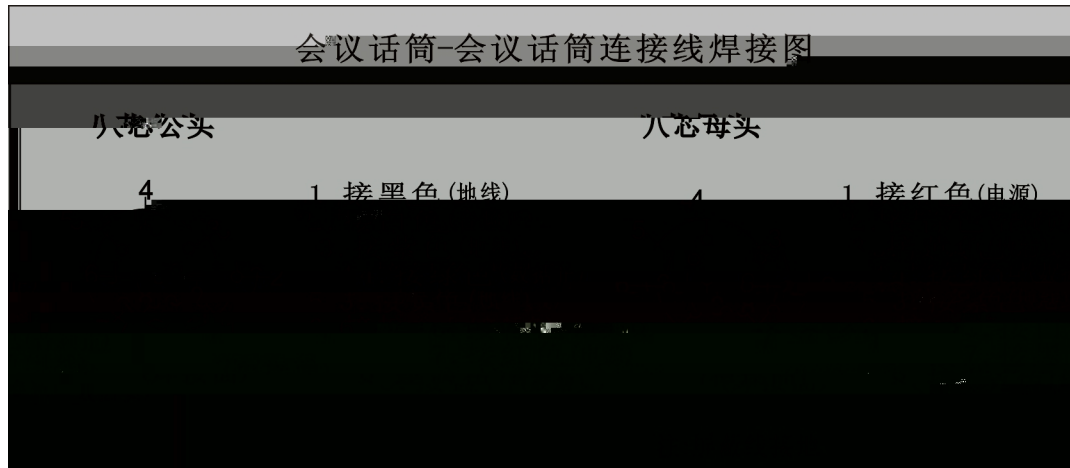

21.2

□

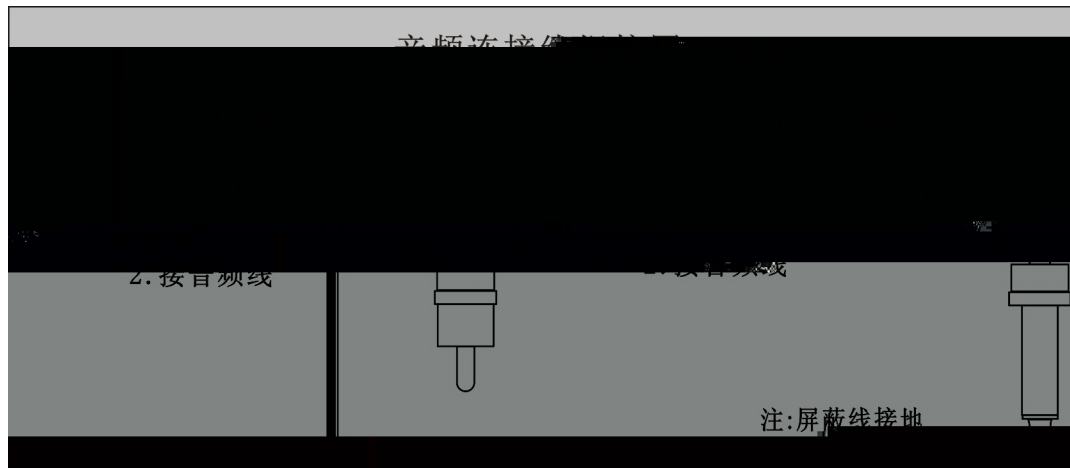

21.3

